

BULLETIN # B011

HOW TO REPLACE THE LITHIUM OR NiCad BATTERY FOR MEMORY BACK-UP IN ATL-1, 2, 2+, 3, 2000, 3000, and 2X00's

You will need:

- Medium size standard blade screwdriver
- Phillips® #1 head screwdriver
- Soldering iron (low wattage pencil type)
- Solder (60% tin/40% lead type)
- Volt meter
- Wire cutter (small)
- If you own an ATL-2+, 3mm hex ball head driver or 3mm Allen key supplied with your processor (*JOB Part #16227*)

JOB spare parts you will need for this procedure are:

- ATL-1's mostly use NiCad Battery (*JOB Part #48100*). Some late production ATL-1's use a Lithium Battery (*JOB Part #48105*).

NOTE: These battery types are NOT INTER- CHANGEABLE! They are circuit board type dependent.

- ATL-2, ATL-2+, ATL-3, ATL-2000, ATL-3000, and all ATL-2X00's only use (*JOB Part #48105 Lithium Battery*).
- Electronics Head seal tape, (*JOB Part #70238*).

NOTE: THE CIRCUIT BOARDS ARE STATIC SENSITIVE. USE CARE WHEN HANDLING THEM. DO NOT TOUCH THE SURFACES. HANDLE BY EDGES ONLY!

There are 6 parts to this bulletin:

- If you own an ATL-2, ATL-2+, or ATL-3, direct your attention to parts #1 and #5.
- If you own an ATL-1, direct your attention to parts #2 and #4 or #5.
- If you own an ATL-2000, ATL-3000, or ATL-2X00's, direct your attention to parts #3 and #6.

PART ONE

Accessing the Lithium Battery

In an ATL-2, 2+, or 3

1. Remove the fuse access panel by first removing the 2 Phillips screws located just below the display/keypad panel. If you own an ATL-2+, you must remove the front bottle cover and remove the 3mm Allen screw located by the left hinge before removing the access panel.
2. Slide the access panel toward you being careful not to lose the rubber grommet(s) on the right side of the panel.
3. Located behind the fuse access panel, you will find 2 cables; one gray ribbon cable, and one round gray cable with black locking connectors.

4. At the top of the ribbon cable you will see a hinge or tab on either side of the connector. Move both of them out to the side and slightly up to push the ribbon cable connector out of its receptacle.

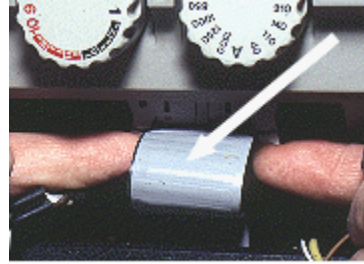

5. Located on the round gray cable you will find a black locking connector. Pull the cable apart at the connector.



NOTE: This connection can be difficult to open! Do not use any tools to pry this connector apart!

6. There is a Phillips screw located in each of the lower left hand and right hand corners of the upper Electronics Head. Remove the screws. **Be careful not to drop the screws into the fuse access area!**



7. Remove the two small Phillips screws located above the display/keypad panel in the upper left hand and right hand corners of the Electronics Head.

8. Lean the front panel of the Electronics Head forward and while holding the panel, carefully disconnect the gray ribbon cable from the back of the front circuit board. This can be done most easily by using a standard blade screwdriver to lift the gray connector off the black socket. Also, disconnect the red and black wires from the same board.

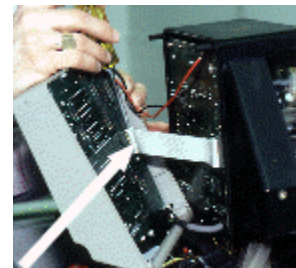

NOTE: Do not pull on the red (5V) and black (0V) wires! Instead push the wire connectors off with a screwdriver. These connectors will break if bent.

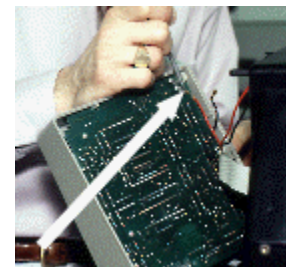

9. Pull the knobs off the front panel.

NOTE: The ml switch and the PROGRAM switch have a washer.

10. Turn the front panel over and place on a level surface. Remove the 4 Phillips screws that mount the exposed board (the control circuit board).

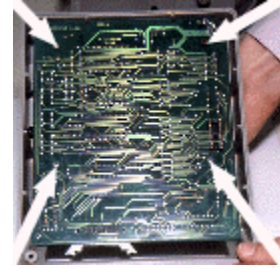

11. Carefully lift out the control circuit board. There are 2 ribbon cables attached to the front the control circuit board. Carefully disconnect them, using a standard blade screwdriver to lift the connector off the socket.

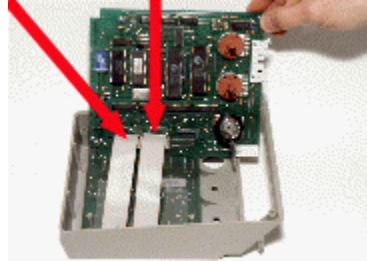

12. Direct your attention to [Part 5 of this bulletin.click here](#)

PART TWO

Accessing the Lithium or NiCad Battery In an ATL-1

1. If you own an ATL-1, remove the Electronics Head. For instructions on removing the Electronics Head, refer to [bulletin #10a](#).

2. Remove the sealing tape from the top of the electronics head.



3. After removing the Electronics Head from the mechanical section, lay the Electronics Head face down on a soft surface. Locate and remove the two standard screws recessed approximately 1 inch into the head. They are located in upper left hand and right hand corners.

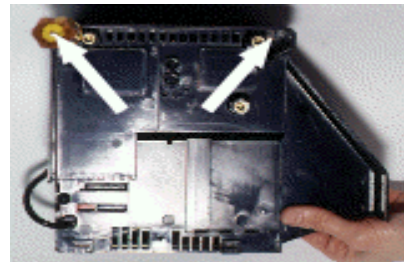

4. Turn the Head over and remove the 2 Phillips screws located in the lower right hand and left hand corners of the unit.

5. Remove the knob covers.

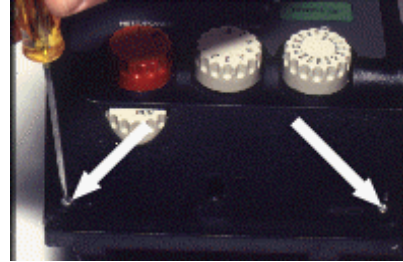

6. Lift the top panel off to the left and prop it on a book or other suitable item.



7. Remove the 4 Phillips screws that mount the circuit board in the front half of the unit.

8. Carefully lift out the board. There are 3 ribbon cables, one red and one black wire attached to the front of the board. Carefully disconnect the wires and cables, using a standard blade screwdriver to assist.

NOTE: These connectors may break if bent.



9. Refer to the block diagrams #1 and #2 at the end of this bulletin to determine if your ATL-1 uses the NiCad Battery or the Lithium Battery.

10. If you need the Lithium Battery, direct your attention to [part 5](#) of this bulletin. If you need the NiCad Battery, go to [part 4](#).

PART THREE

Accessing the Lithium Battery In an ATL-2000, ATL-3000, and ATL-2X00's

1. Remove the four (4) Phillips screws located on the front of the electronics head. Please note the two upper screws are longer than the two lower screws.
2. Remove the gray colored sealing tape (JOB0 Part #70238) and remove the front cover of the electronics head.



WARNING! It is critical this tape is replaced before using your processor. If liquids are spilled on the top of the electronics head and the seal tape is not present, then severe damage to the electronic circuit boards will occur!

3. Unplug the multicolored ribbon cable from the upper circuit board (control circuit board) by gently pulling the female section of the connector out of the male section of the same connector.

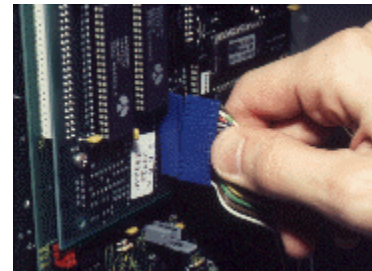

4. Remove the four 4 Phillips screws from the control circuit board.

NOTE: Use caution by not touching the components on the control circuit board!



5. Carefully remove the control circuit board by holding the circuit board on the left hand and right hand sides. Then gently pull the control circuit board off of the rear circuit board.

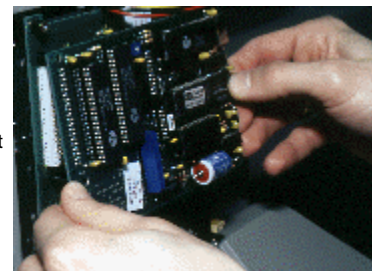

6. Lay the control circuit board on a static proof surface. For example, place several sheets of paper on a table top and place the circuit board on top of the paper.

NOTE: When attaching the control board after the installation of the new battery, make sure you align all of the pins and connectors located on the back side of the control board before you press the card back into position.

PART FOUR

NiCad Battery Replacement in most ATL-1's

1. The NiCad Battery has three pins. Two pins are located on the right side (+ = positive) and one pin is located on the left side (- = negative). If you measure the voltage of the battery, leaving one meter probe on the single pin, there should be 1.8V at each of the other pins. ([See diagram CIRCUIT BOARD #1](#)) [click here](#).

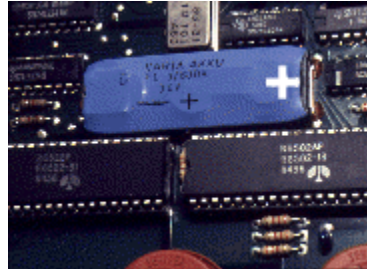

2. Remove the old battery using a desoldering tool or a soldering iron.
3. Insert the new battery and solder it into place. ([See diagram CIRCUIT BOARD #1](#)) [click here](#).
4. Reassemble the Electronics Head .

5. When reconnecting the red and black wires, red goes to 5 volts and black goes to 0 volts. The board is labeled.



NOTE: Use a screwdriver to gently push the red and black wires onto the connectors.

PART FIVE

Lithium Battery Replacement for some ATL-1's and all ATL-2, 2+, and 3

1. The new lithium battery should be 3.6V.

2. Remove the old battery, located toward the top of the board, with a desoldering tool or a soldering iron. ([See diagram CIRCUIT BOARD #2](#)) [click here](#)



3. Insert the new battery. Be sure to check the polarity and then solder it in place.

NOTE: Both the battery and the board are labeled for polarity. Look for the plus "+" sign. (See [diagram CIRCUIT BOARD #2](#)) *click here.*

4. Trim the leads using a wire cutter.
5. Reassemble Electronics head.

6. When reconnecting the red and black wires, the red wire connects to the 5 volt terminal (5V) and the black wire connects to the 0 volt terminal (0V).

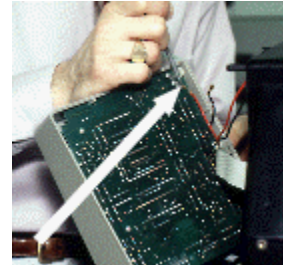

NOTE: Use a screwdriver to gently push the red and black wires onto the connectors.

PART SIX

Lithium Battery Replacement for

ATL-2000, 3000 and all 2X00's

1. The new lithium battery should be 3.6V.

2. Remove the old battery, located toward the bottom of the board, with a desoldering tool or a soldering iron. (See [diagram CIRCUIT BOARD #3](#)) *click here.*



3. Insert the new battery. Be sure to check the polarity and then solder it in place.

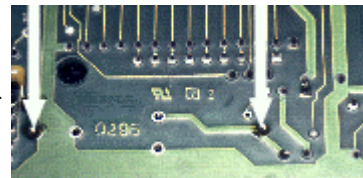

NOTE: Both the battery and the board are labeled for polarity. Look for the plus "+" sign. (See [diagram CIRCUIT BOARD #3](#)) *click here*

4. Trim the leads using a wire cutter.

5. Reassemble Electronics head.

NOTE: When attaching the control board after the installation of the new battery, make sure you align all of the pins and connectors located on the back side of the control board before you press the card back into position.

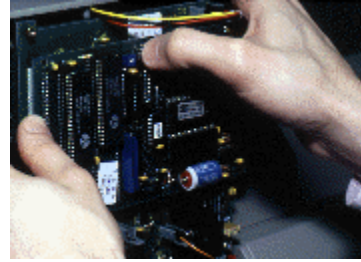

CIRCUIT BOARD DIAGRAMS #1, #2, AND #3 ARE LOCATED BELOW:

ATL-1 Control Circuit Board with the *NiCad* Battery FIG#1

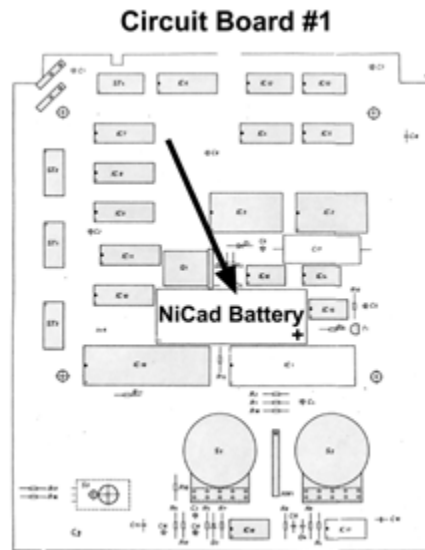

ATL-2, 2+, 3 Control Circuit Board with the *Lithium* Battery

FIG#2

Circuit Board #2

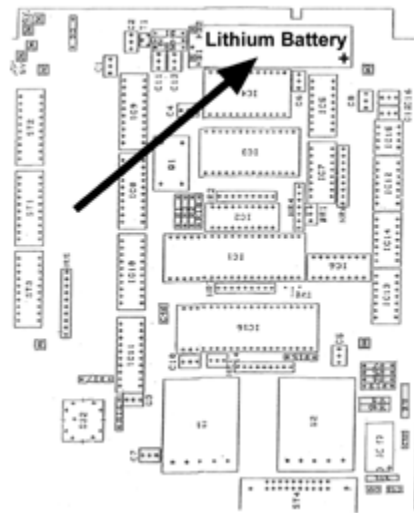

ATL-2000, 3000, 2X00 Control Circuit Board
with the *Lithium* Battery

FIG#3

Circuit Board #3

